

1. Türvorbereitung, Door preparation, Préparation

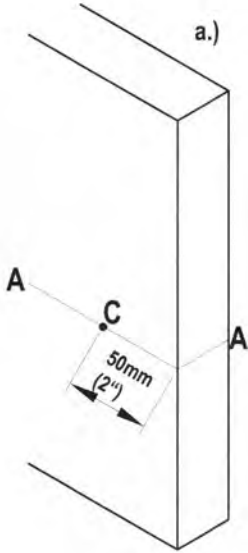

Zeichnen Sie eine Linie "A" mit der Länge 76mm auf beide Seiten der Tür und auf die Stirnseite der Tür. Diese Linie ist die Mittellinie, und legt die Position der Rosette fest. Die Höhe der Mittellinie kann selbst festgelegt werden. Empfehlenswert ist die Höhe 910mm

Markieren Sie mit einem Abstand von 50mm gemessen von der Stirnseite der Tür einen Punkt. Dies ist der Punkt C.

Draw a level 76mm (3") center line "A" on both sides of the door and on the edge of the door. The standard height for pocket door privacy kit is 910mm (36") from finished floor. This centered line determines the position of the rose. Please mark the center of the rose with a distance of 50mm (2") from the edge of the door. Name this point C

Dessinez une plaine de 76 mm ligne des centres "A" sur les deux côtés de la porte et aussi sur le bord de la porte. Hauteur standard des poignées cuvette est 910 mm du fond. La ligne des centres détermine la position de la rosace. Marquez le centre de la rosace avec une distance de 50 mm du bord de la porte. Nommez ce point avec "C".

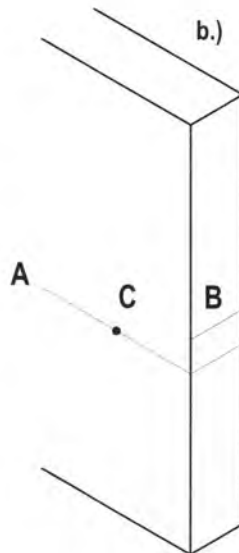

Zeichnen Sie eine zweite Mittellinie "B" auf der Stirnseite der Tür. Die Linie B ist 20mm oberhalb der Linie "A"

Draw a second center line "B" on the edge of the door which is 20mm (13/16") above center line "A"

Marquez une deuxième ligne "B" sur le bord de la porte. Cette ligne est située 20 mm au dessus de la ligne "A".

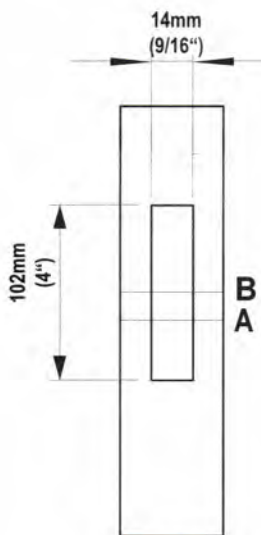

Fräsen Sie in die Stirnseite der Tür eine Schloßtasche mit den Maßen 102mm x 14mm. Die Tiefe der Schloßtasche beträgt 75mm. Die Fräsung soll mittig zum Türblatt und zur Linie B sein.

Cut out a rectangular shape 102mm x 14mm (4" x 9/16") at the edge of door with a depth of 75mm (3"). The center of the rectangular shape is centerline "B"

Coupez une forme rectangulaire de 102 x 14 mm dans le bord de la porte avec une profondeur de 75 mm. Le centre de la forme rectangulaire est ligne des centres "B"

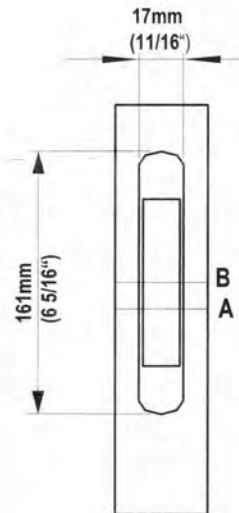

Für den Stulp wird eine weitere Fräsung mit den Maßen 161mm x 17mm x 2mm benötigt. Bitte beachten Sie die Rundungen des Stulps. (Fräsdurchmesser Ø17mm)

For the forend plate cut out a 161mm x 17mm x 2mm (6 5/16" x 11/16" x 1/8") base. The center of the rectangular shape is centerline "B". The forend plate has rounded corners. Milling diameter is 17mm (11/16")

Coupez un fond de 161mm x 17mm x 2mm dans la plaque fin de tête. Le centre de la forme rectangulaire est ligne des centres "B". La plaque fin de tête est avec des angles arrondis. (Diamètre de fraisage 17mm)

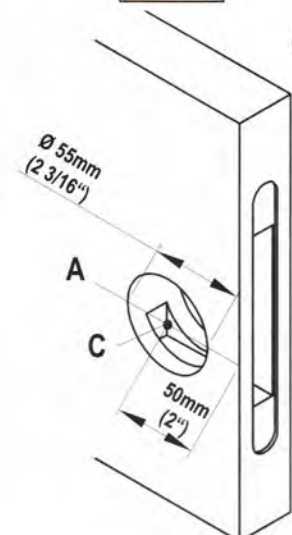

Fräsen Sie ein Loch (Ø55mm) halb durch die Tür von beiden Seiten um eine Beschädigung durch Splintern zu vermeiden. Der Mittelpunkt ist der Punkt C, der unter a.) festgelegt wurde.

Bore a 55mm (2 1/8") hole in the door face half way through the door on each side to prevent splintering of door. The center of the hole „C“ was determined under point a.)

Percez un trou de Ø 55 mm dans la porte, fraisez dans la porte à demi de deux côtés pour éviter des éclats. Le centre du trou „C“ avait été déterminé sous numérotation a.)

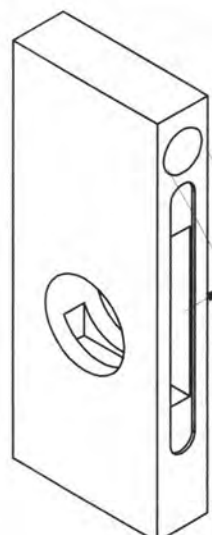

Fräsen sie an der Stirnseite der Tür mit einem Durchmesser von Ø25mm, ein 25mm tiefes Loch für die Fingermuschel. Auf Kundenwunsch können Sie die Fingermuschel versenken. Die Maße betragen Ø29mm x 1,6mm (Eckige Version 29mm x 29mm x 1,6mm)

Bore at the edge of the door a 25mm (1") deep hole with a Ø25mm (1") diameter for the finger pull. To mount the finger pull flush the measures are Ø29mm x 1,6mm (Ø 1 1/8" x 1/16") for the square version 29mm x 29mm x 1,6mm (1 1/8" x 1 1/8" x 1/16")

Percez un trou avec une profondeur de 25mm et un diamètre de 25mm pour le tirage de doigt. Vous pouvez enfoncer la cuvette pour le doigt à la demande du client. Les dimensions sont Ø29 mm x 1,6 mm. (Pour la version carrée 29mm x 29mm x 1,6mm)

La position pour le tirage de doigt peut être choisi par le client. Nous recommandons un tirage de doigt de 50 mm au dessus du perçage.

2. Montage, Installation Instructions, Instruction de montage

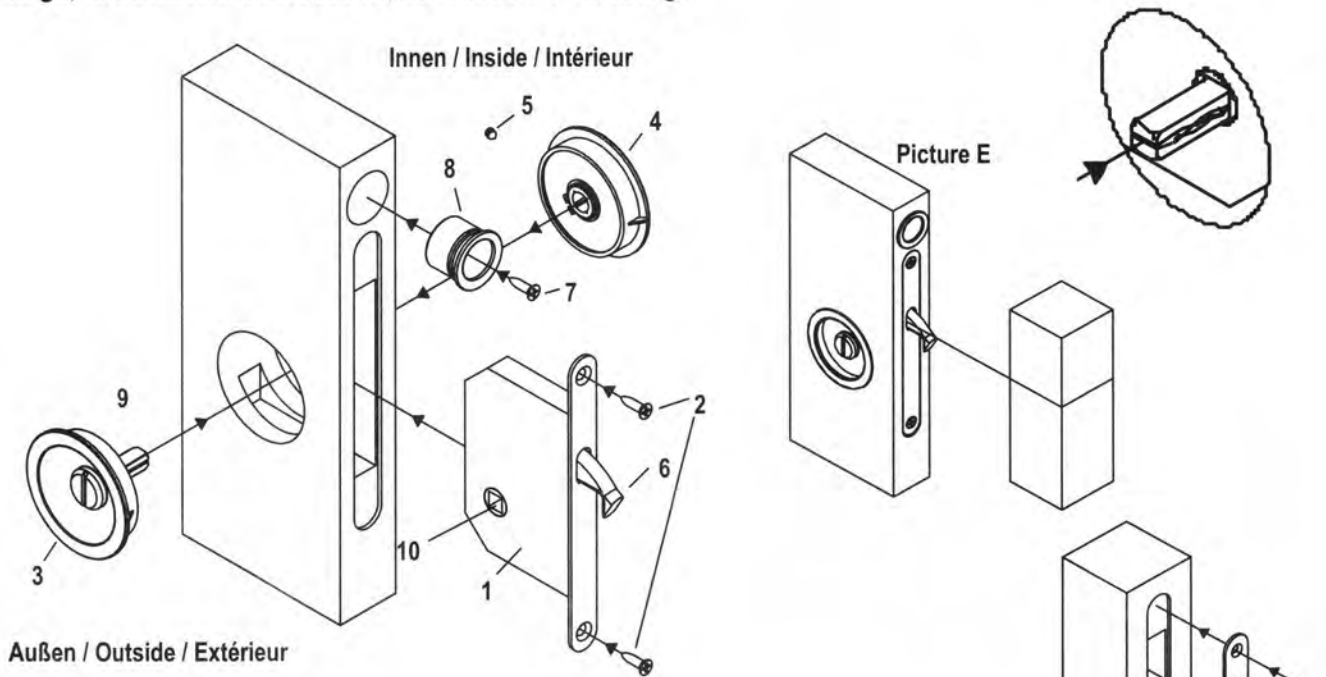

- | | | |
|---|---|--|
| <p>a.) Montieren Sie den Schloßkasten (1) mit den Holzschrauben (2).</p> <p>b.) Schieben Sie den Vierkantstift (9), der mit der Außenrosette (3) (Schlitzseite) verbunden ist durch die Schloßnuss (10). Achten Sie darauf, dass der Vierkantstift (9) so angeordnet ist, dass die Madenschraube (5) des Knebels auf der Innenrosette in den Spalt treffen kann.</p> <p>c.) Stecken Sie die Innenrosette mit Knebel (4) auf der Gegenseite in die Bohrung, so dass die Madenschraube des Knebels in die Kerbe trifft. Drehen Sie die Madenschraube (5) fest.</p> <p>d.) Stecken Sie die Fingermuschel in die Bohrung und befestigen Sie diese mit der Schraube (7)</p> <p>e.) Markieren Sie auf der Gegenseite die Stelle für das Schließblech. Fräsen Sie eine Tasche mit den Maßen H x B x T (54mm x 14mm x 25mm) aus.</p> <p>f.) Versenken Sie das Schließblech (161mm x 18mm x 2mm), so dass der Haken des Schlosses im Schließblech gehalten wird. Bitte beachten Sie die Rundungen des Schließbleches (Fräsdurchmesser 18mm)
Montieren Sie es mit Holzschrauben (2)</p> <p>g.) Wenn nötig können die Rosetten und die Fingermuschel mit Silikonkleber festgeklebt werden. Die Verwendung von Silikonkleber wird insbesondere für die eckige Version</p> | <p>a.) Install the lock (1) using wood screws provided (2). The lock follower for the square spindle (8) has to be on the lower side of the lock</p> <p>b.) Insert the outside rose (3) which is connected to the spindle (8) through the lockfollower (10) in the way that the point of the grub screw will meet the oval slot in the spindle.</p> <p>c.) Insert the inside rose (4) to the spindle. Fix the outside rose with the grub screw</p> <p>d.) Insert the finger pull and fix it with the wood screw (7)</p> <p>e.) Roses and finger pull can be fixed additionally with silicon glue if necessary.</p> <p>f.) Slide pocket door closed hitting with bolt (6) the jamb to mark location. (Pic. E.) 54mm x 14mm x 25mm (2 1/8" x 9/16" x 1").</p> <p>g.) Place the strike plate in this way that the latch bolt while closed is hold by the strike plate. Cut out cut out a 161mm x 17mm x 2mm (3 9/16" x 11/16" x 1/8") base. The strike plate has round corners. Milling diameter is 18mm (11/16mm). Secure with the wood screws provided</p> <p>h.) If necessary silicon glue can be used. This is particularly recommended for the square shaped version to avoid a turn out of position after fixture.</p> | <p>a.) Installez la serrure (1). Utilisez les vis à bois livrées (2). The lock follower for the square spindle (8) has to be on the lower side of the lock</p> <p>b.) Implantez la rosace extérieure (3) qui est attaché au carré (8) par le guidage de serrure (10) de manière à ce que le point de la vis pointeau touche la fente ovale du carré.</p> <p>c.) Implantez la rosace intérieure (4) au carré. Vissez la rosace extérieure avec la vis pointeau.</p> <p>d.) Implantez le tirage de doigt et vissez-le avec des vis à bois (7)</p> <p>e.) Les rosaces et le tirage de doigt peut être fixé supplément avec colle silicone si nécessaire.</p> <p>f.) Enfoncez-vous le meneau de la porte coulissante fermé avec un clou pour marquer la position. Coupez à 54 mm x 14 mm x 25 mm</p> <p>g.) Positionnez la plaque "strike" de manière à ce que le "latch" ferme pendant c'est barrer est c'est arrêter par la plaque "strike" Coupez une forme de 161mm x 18mm x 2 mm. La plaque "strike" est avec des angles arrondis. (Diamètre de fraisage 18mm) Fixez avec des vis à bois livrées.</p> <p>h.) Si nécessaire, les rosaces et les poignées cuvettes peuvent être collés avec silicone adhésif. L'utilisation de colle silicone est recommandé, surtout pour la version carrée pour empêcher une rotation ultérieure.</p> |
|---|---|--|

For USA Limited Warranty

Kärcher GmbH ("Kärcher") warrants to the original retail purchaser ("Purchaser"), but to no other person, that Kärcher's products ("Products") shall be free from defects in material or workmanship for a period of one (1) year following the purchase of the Products from an authorized dealer. Kärcher's sole obligation under this limited warranty shall be, at the option of Kärcher, to repair or replace Products which Kärcher determines, in its sole discretion, to be defective and which are returned to Kärcher by an authorized dealer within one (1) year from the date of purchase of the Products.

Kärcher does not assume any warranty responsibility for damage to the Products due to conditions over which Kärcher has no control, including but not limited to ordinary wear and tear, improper installation or maintenance, alteration, impact, accident, misuse, tampering or abuse. Kärcher assumes no responsibility for tarnishing, discoloration, excessive wear or deterioration of the surface finishes due to exposure to weather conditions over which Kärcher has no control. Kärcher assumes no responsibility for any defects or damage caused by the Purchaser or any third parties.

KÄRCHER MAKES NO OTHER WARRANTIES OF ANY KIND OTHER THAN THOSE CONTAINED HEREIN AND HEREBY DISCLAIMS ALL OTHER WARRANTIES, EXPRESS OR IMPLIED, WITH RESPECT TO THE PRODUCTS INCLUDING WITHOUT LIMITATION ANY WARRANTIES OF MERCHANTABILITY OR FITNESS FOR A PARTICULAR PURPOSE. THIS LIMITED WARRANTY IS IN LIEU OF ALL OTHER WARRANTIES, EXPRESS OR IMPLIED, AND IS LIMITED TO THE DURATION OF THE LIMITED WARRANTY PERIOD. IN NO EVENT SHALL KÄRCHER BE LIABLE FOR ANY SPECIAL, DIRECT, INDIRECT, INCIDENTAL, OR CONSEQUENTIAL DAMAGES, INCLUDING, BUT NOT LIMITED TO LOSS OF PROFITS, PROPERTY DAMAGE, DAMAGES TO BUSINESS OR BUSINESS RELATIONS, OR DAMAGES FOR LOSS OF OPERATION. THIS WARRANTY REPRESENTS KÄRCHER'S SOLE LIABILITY TO THE PURCHASER FOR CLAIMS RELATED TO THE PRODUCTS WHETHER THE CLAIMS ARE BASED UPON CONTRACT, TORT, OR ANY OTHER LEGAL THEORY. Kärcher's total cumulative liability under this limited warranty, if any, is limited to the dollar amount of the Purchaser's original payment for the Products.

The invalidity or unenforceability of any provision of this limited warranty shall not affect the validity and enforceability of any remaining provisions, and this limited warranty and disclaimer of liability shall be construed in all respects as if any invalid or unenforceable provision is omitted.

Some states do not allow limitation on how long an implied warranty lasts or the exclusion or limitation of incidental or consequential damages so the above limitations or exclusions may not apply to you, the buyer.

This warranty gives you specific legal rights and may also have other rights which vary from state to state.

KÄRCHER
Design
DESIGN

Kärcher GmbH
Design-Beschläge
Raiffeisenstr.32
74906 Bad Rappenau
+49-7264-91640
+49-7264-916440
mail@kärcher-design.de
www.kärcher-design.de

